

# Bike Rack Installation Instructions

## Cora Bike Rack - CWR Series Wall Mounted Racks (CWR'1')

This instruction sheet is to be used for CWR1 Wall Mounted Rack.

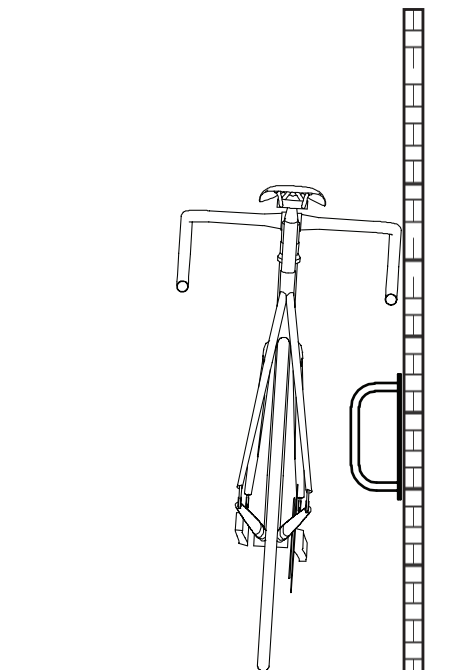
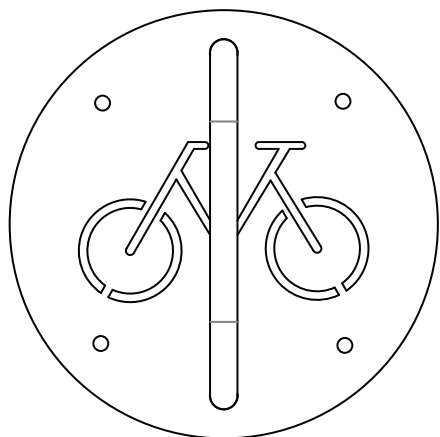

Components for CWR1 Rack used in assembly

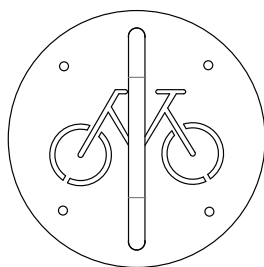

CWR1 Rack  
(x1)

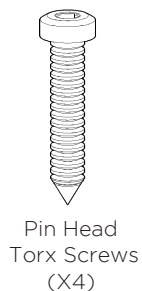

Pin Head  
Torx Screws  
(X4)



Nylon Wall  
Plugs  
(X4)



Pin Head Torx  
Screws Tool Bit  
(X1)



Washers  
(X4)

### 1. Site selection

When selecting a site for your new bicycle rack, the most important advice is;

**Do not try to hide it, as it will not be used!**

Suitable locations include;

- Adjacent to entrance doors and in line of sight of a window
- Near high pedestrian traffic
- Covered areas

Other things to remember;

- Where a rack is being installed at an existing location, the rack should be placed where bicycles are currently parked
- When using a garage location, it is recommended to use a parking bay that is nearest to an entrance door.

# Bike Rack Installation Instructions

## Cora Bike Rack - CWR Series Wall Mounted Racks (CWR'1')

### 2. Access and clearance

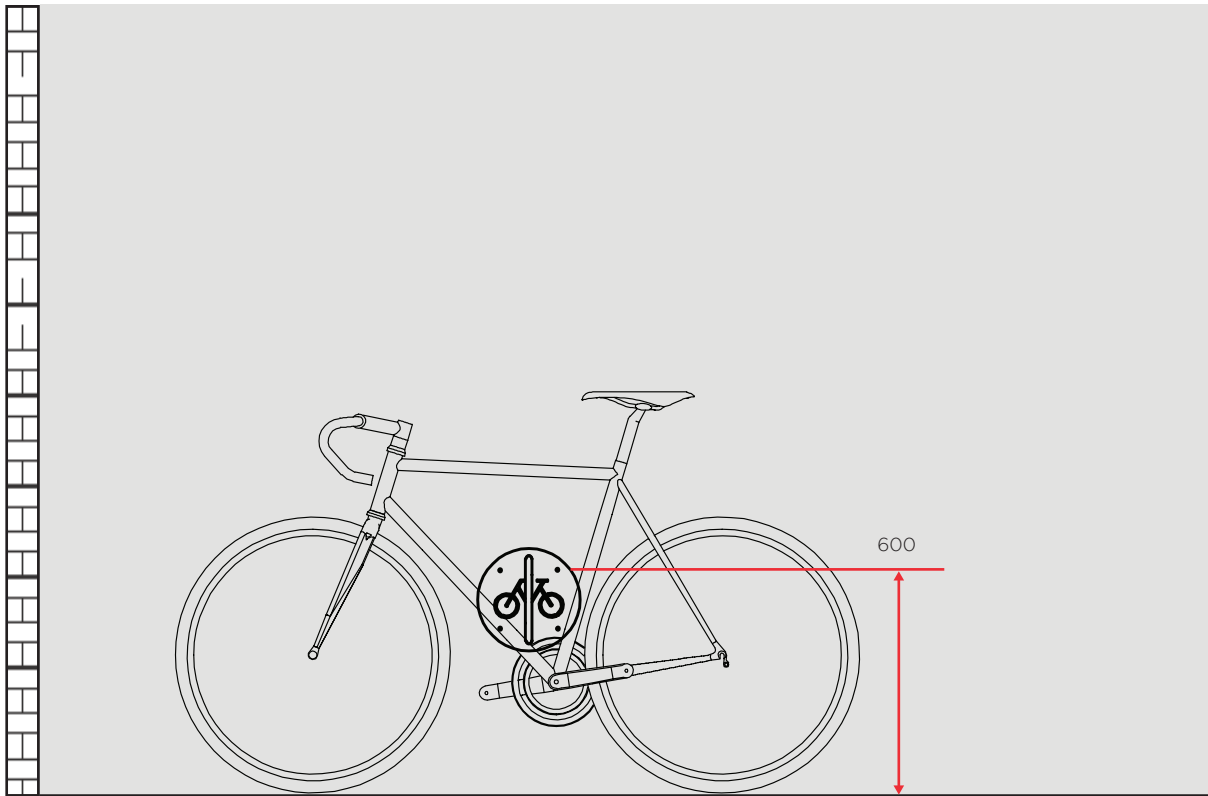

- Rack to be positioned 600mm to highest fixing point from the ground.

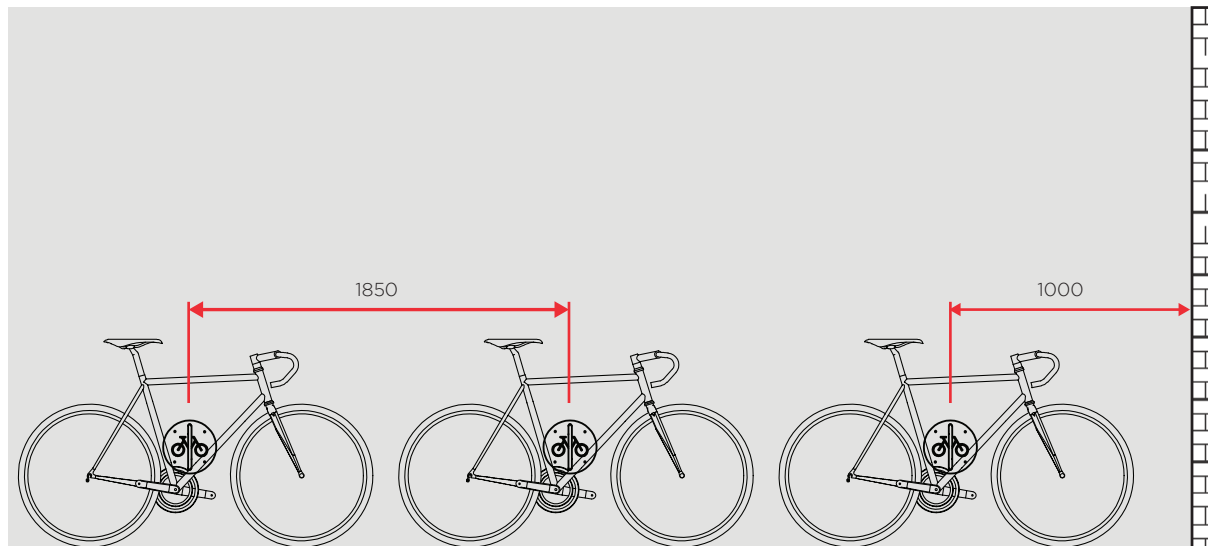

- Adjacent racks must be positioned a minimum of 1850mm centre to centre, and 1000mm to any obstruction.
- Reduced spacings are possible where compliance with AS2890.3 (2015) is not required. Reduced spacing is less user friendly.

# Bike Rack Installation Instructions

## Cora Bike Rack - CWR Series Wall Mounted Racks (CWR'1')

### 3. Locate and measure suitable location

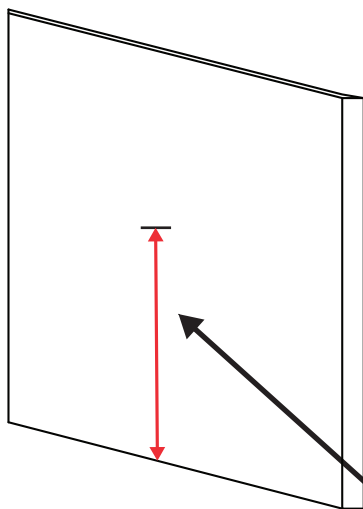

- Locate suitable area for rack installation with correct clearance on all sides.
- Draw a horizontal line to mark height of higher fixing point 600mm from ground

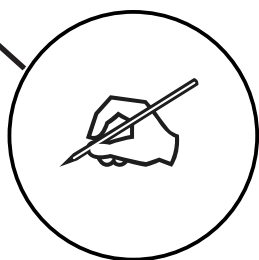

### 4. Mark and drill fixing points

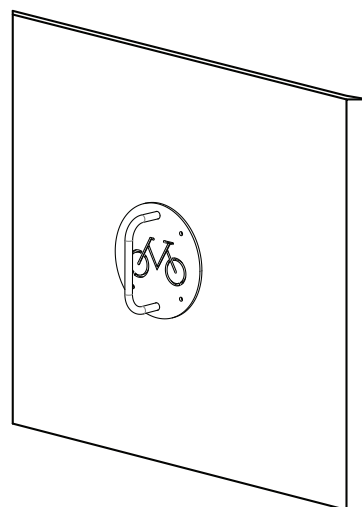
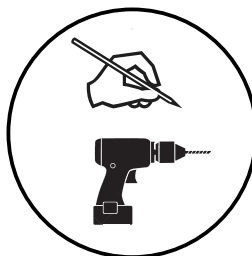

- Place rack in desired position and mark all fixing points with a suitable marker.
- Drill holes using a 10mm masonry drill bit to a depth of 40mm. For best results use a 6mm bit first to prevent wandering of the larger bit. Clear holes of dust.

**Do not drill over plumbing and/or electrical conduits.**

### 5. Fix rack into position

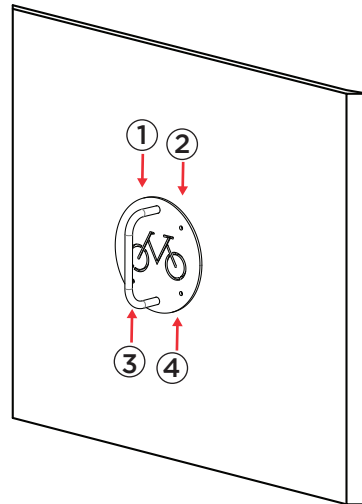
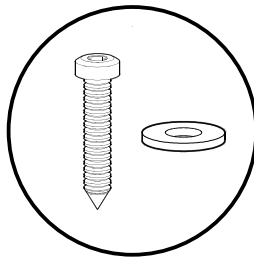
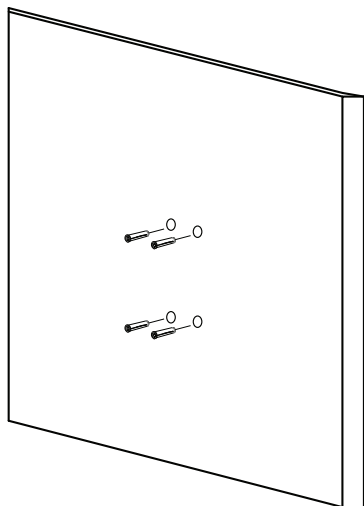
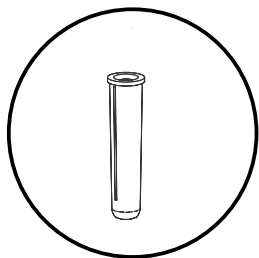

- Tap nylon sleeves into holes. Place rack in position and partially tighten screws starting from the top position. Once all screws are in, continue to tighten until firm.

# Bike Rack Installation Instructions

## Cora Bike Rack - CWR Series Wall Mounted Racks (CWR'1')

---

6. Installation complete

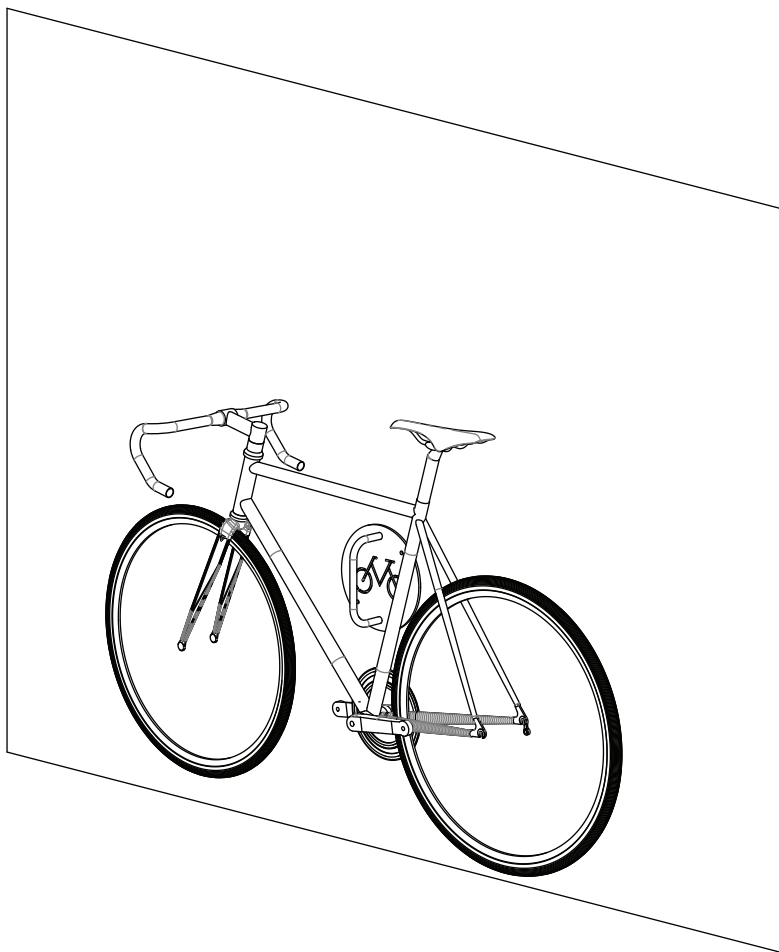

Installation of the Cora CWR1 rack is now complete

